

# WaveLab 式24GHz帯 T/R

JA0DFR 2024/03/05

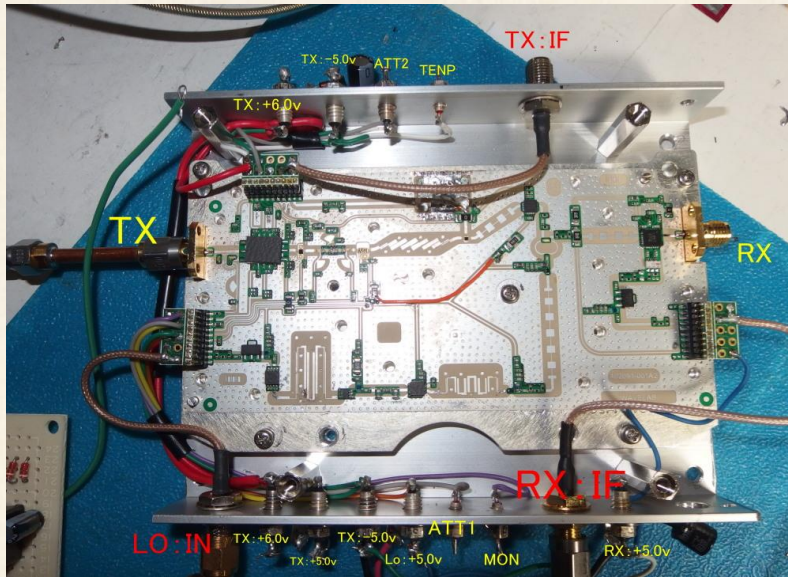

## 局発電源接続改造

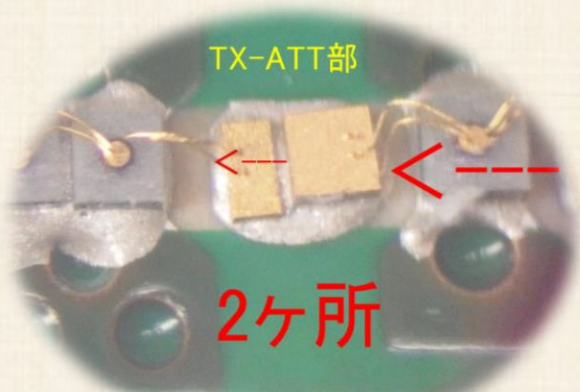
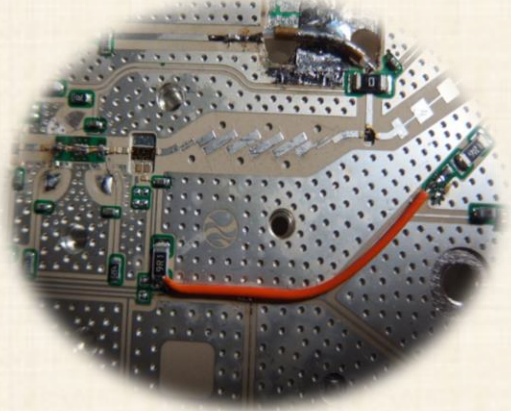

## Pin ATT部 ワイヤー破損

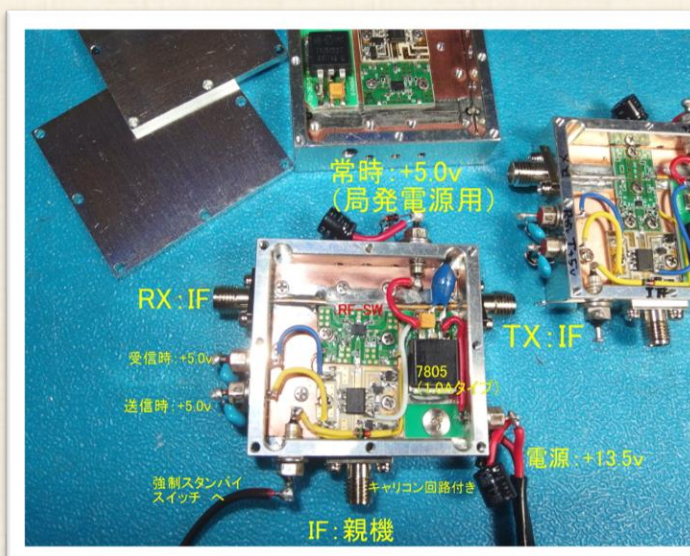
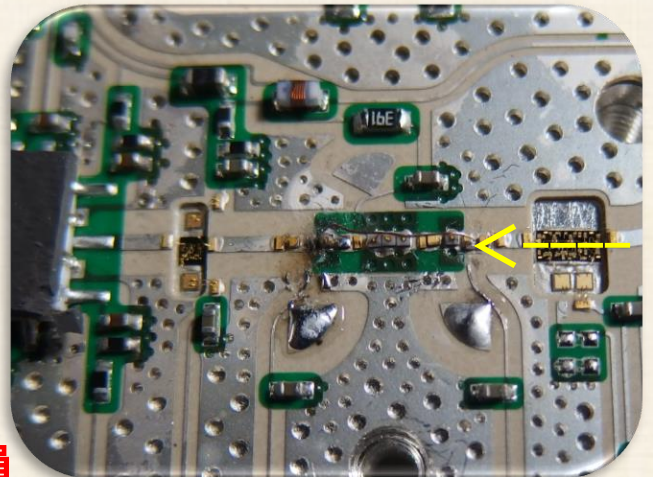

## IF切り替え器



## 出力: 1.75w (24.020GHz)

# WaveLab 式24GHz帯 液晶表示

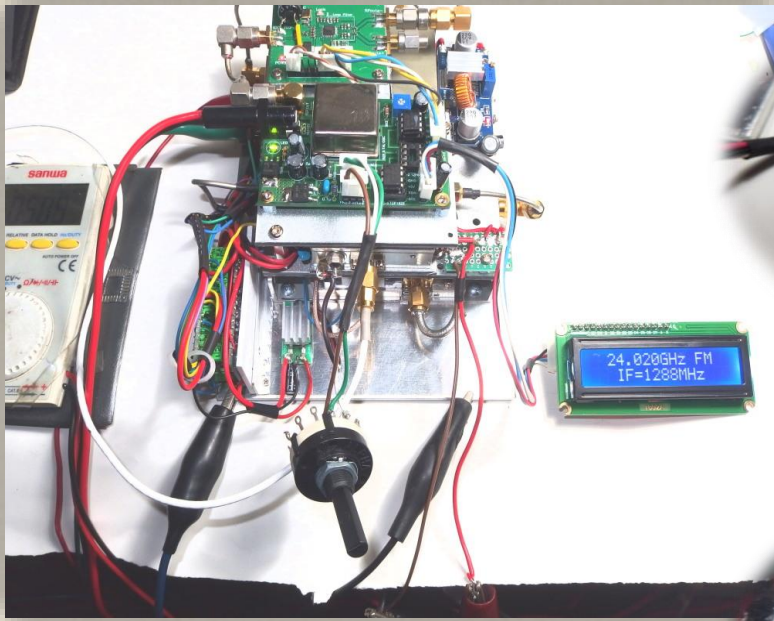

周波数: 24.020GHz

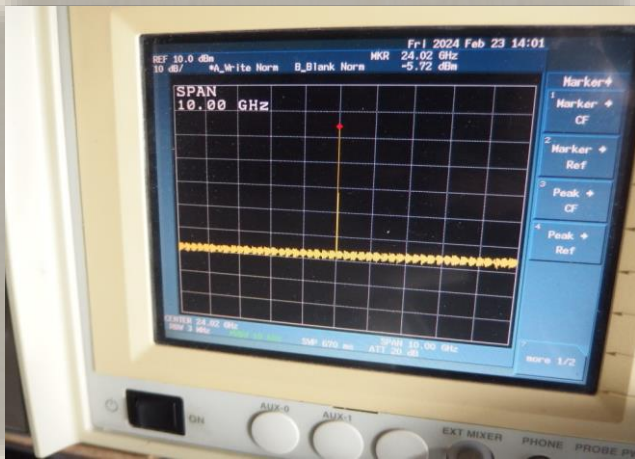

周波数: 24.005GHz

